



DWMM4[G]-6-60

- 4x4 MiMo 4G/5G Omni-Directional Antenna Solution
- Mast, Wall or Desk Mount
- Optional GPS/GNSS - 26dB LNA
- Integral FRZH Rated Coaxial Cables

The DWMM4[G]-6-60 antenna provides a 4x4 MiMo omnidirectional antenna solution for global 4G/5G networks covering 617-6000MHz. It features four separately fed ultra-wideband elements in a single housing and is suitable for a wide range of fixed-site branch office and enterprise failover applications.

The supplied mounting bracket enables mast mounting using the supplied clamp assembly or it can be wall-mounted using the supplied screws and wall plugs. The antenna can be fitted directly to non-conductive panels or internal walls and mounting feet are supplied to allow it to be stood on a desk or window sill.

The omni-directional radiation pattern allows easy placement of the antenna without consideration of directional alignment and makes it ideal where access to multiple network sites is required. The DWMM4G version incorporates an integral GPS/GNSS antenna with 26dB LNA gain and advanced filtering for resilient operation.

The antenna has integral flame retardant coaxial cables, which eliminates or reduces exposed connector joints and simplify installation.

Technical Drawing

DWMM4G-6-60-5SP Shown

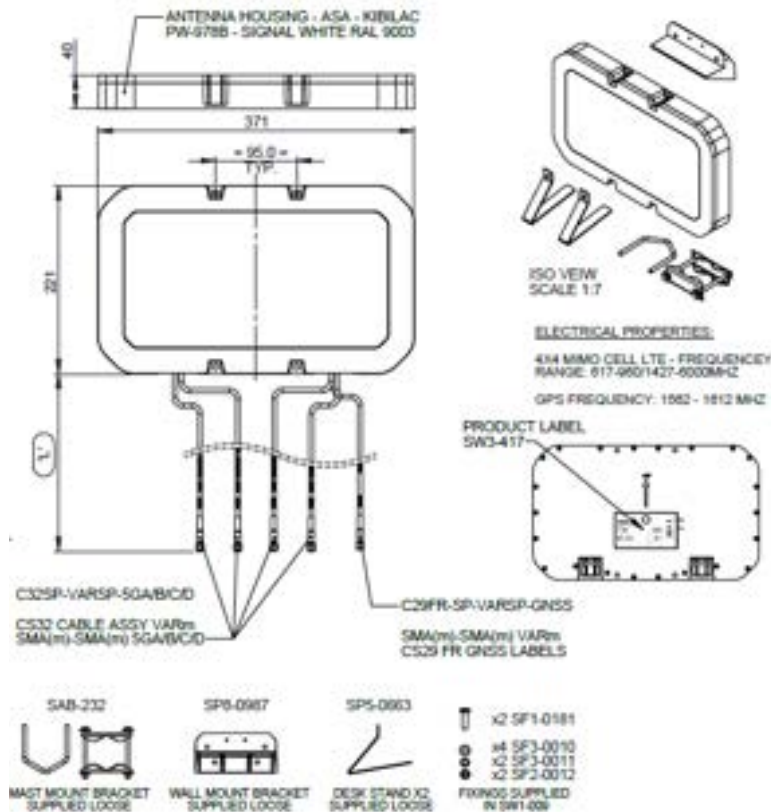

4x4 MiMo 4G/5G Antenna

DWMM4[G]-6-60

Product Data

Part No.		DWMM4-6-60-5SP	DWMM4-6-60-5FKJ	DWMM4-6-60-5NP	DWMM4-6-60-05NJ
Electrical Data					
Frequency Range (MHz)	Elements 1-4	617-960 / 1427-6000			
Operational Band	Elements 1-4	2G/3G/4G/5G			
Typical VSWR**		<2.5:1			
Correlation Co-efficient		< 0.1			
Polarisation		+/-45 degrees			
Pattern		Hybrid			
Impedance		50Ω			
Max Input Power (W)		10			
Mechanical Data					
Dimensions (mm)	Length	371 (14.6")			
	Height Excl Brkt	221 (8.7")			
	Depth	40 (1.57")			
Operating Temp (°C)		-40° / +85°C (-40° / 185°F)			
Radome Material		ASA			
Material Approvals		Radome ASA Material - UL 746C F1, UL 94-HB			
Colour		White			
Ingress Protection		IP66			
Mounting Data					
Fixing		Wall, Mast, Rail or Panel Mount			
Max Mast / Rail Diameter (mm)		50 (1.96")			
Cable Data					
4G/5G Cables	Type	CS32 (EN45545-2)			
	Diameter (mm)	5 (0.19")			
	Length (m)	5 (16' 4")	5 (16' 4")	5 (16' 4")	0.5 (1' 6")
	Termination	SMA (m)	FAKRA D Jack	N (m)	N(f)

* Peak gain and efficiency simulated in CST microwave studio for each element in free space excluding cable loss ** Typical VSWR measured with 0.5m (1.5') of cable in free space.

4x4 MiMo 4G/5G Antenna

DWMM4[G]-6-60

Product Data					
Part No.					
	DWMM4G-6-60-5SP	DWMM4G-6-60-5FKJ	DWMM4G-6-60-5NP	DWMM4G-6-60-05NJ	
Electrical Data					
Frequency Range (MHz)	Elements 1-4	617-960 / 1427-6000			
	Element 5	1559-1612			
Operational Band	Elements 1-4	2G/3G/4G/5G			
	Element 5	GPS/GNSS			
Typical VSWR**	<2.5:1				
Correlation Co-efficient	< 0.1				
Polarisation	+/-45 degrees				
Pattern	Hybrid				
Impedance	50Ω				
Max Input Power (W)	10				
GPS/GNSS Data					
Frequency Range (MHz)	1559-1612				
Typical VSWR	<2.5:1				
LNA Gain	26dB (+/-3)				
Polarisation	RHCP				
Operating Voltage	3-5 VDC <20ma				
Mechanical Data					
Dimensions (mm)	Length	371 (14.6")			
	Height Excl Brkt	221 (8.7")			
	Depth	40 (1.57")			
Operating Temp (°C)	-40° / +85°C (-40° / 185°F)				
Radome Material	ASA				
Material Approvals	Radome ASA Material - UL 746C F1, UL 94-HB				
Colour	White				
Ingress Protection	IP66				
Mounting Data					
Fixing	Wall, Mast, Rail or Panel Mount				
Max Mast Diameter (mm)	50 (1.96")				
Cable Data					
4G/5G Cables	Type	CS32 (EN45545-2 Compliant)			
	Diameter (mm)	5 (0.19")			
	Length (m)	5 (16' 4")	5 (16' 4")	5 (16' 4")	0.5 (1' 6")
	Termination	SMA (m)	FAKRA D Jack	N (m)	N(f)
GPS/GNSS Cables	Type	CS29 FR (EN45545-2 Compliant)			
	Diameter (mm)	5 (0.19")			
	Length (m)	5 (16' 4")	5 (16' 4")	5 (16' 4")	0.5 (1' 6")
	Termination	SMA (m)	FAKRA C Jack	N (m)	N(f)

* Peak gain and efficiency simulated in CST microwave studio for each element in free space excluding cable loss ** Typical VSWR measured with 0.5m (1.5') of cable in free space.

4x4 MiMo 4G/5G Antenna

DWMM4[G]-6-60

Product Data

Part No.		DWMM4G5-6-60-5SP	DWMM4G5-6-60-05NJ
Electrical Data			
Frequency Range (MHz)	Elements 1-4	617-960 / 1427-6000	
	Element 5	1164-1189 / 1559-1612	
Operational Band	Elements 1-4	2G/3G/4G/5G	
	Element 5	GPS/GNSS	
Typical VSWR**		<2.5:1	
Correlation Co-efficient		< 0.1	
Polarisation		+/-45 degrees	
Pattern		Hybrid	
Impedance		50Ω	
Max Input Power (W)		10	
GPS/GNSS Data			
Frequency Range (MHz)		1164-1189 / 1559-1612	
Typical VSWR		<2.5:1	
LNA Gain		19dB / 29dB (+/-7.5)	
Polarisation		RHCP	
Operating Voltage		3-5v 36ma Typical	
Mechanical Data			
Dimensions (mm)	Length	371 (14.6")	
	Height Excl Brkt	221 (8.7")	
	Depth	40 (1.57")	
Operating Temp (°C)		-40° / +85°C (-40° / 185°F)	
Radome Material		ASA	
Material Approvals		Radome ASA Material - UL 746C F1, UL 94-HB	
Colour		White	
Ingress Protection		IP66	
Mounting Data			
Fixing		Wall, Mast, Rail or Panel Mount	
Max Mast Diameter (mm)		50 (1.96")	
Cable Data			
4G/5G Cables	Type	CS32 (EN45545-2 Compliant)	
	Diameter (mm)	5 (0.19")	
	Length (m)	5 (16' 4")	0.5 (1' 6")
	Termination	SMA (m)	N(f)
GPS/GNSS Cables	Type	CS29 FR (EN45545-2 Compliant)	
	Diameter (mm)	5 (0.19")	
	Length (m)	5 (16' 4")	0.5 (1' 6")
	Termination	SMA (m)	N(f)

* Peak gain and efficiency simulated in CST microwave studio for each element in free space excluding cable loss ** Typical VSWR measured with 0.5m (1.5') of cable in free space.

4x4 MiMo 4G/5G Antenna

DWMM4[G]-6-60

Electrical Data in Free Space

Measurement Conditions	4G/5G Antennas				
Measured in free space with 0.5(1.5') of CS32 cable	Frequency Range (MHz)	LTE Bands	Antenna Element	Peak Gain (dBi)	Efficiency (%)
	617-698	71,105	Cell A	6.4	73
			Cell B	4.8	79
			Cell C	5.3	78
			Cell D	6.4	74
	699-798	12,13, 14 17,28	Cell A	7.4	77
			Cell B	4.0	69
			Cell C	5.3	73
			Cell D	5.1	71
	807- 862	5,19,20,26,27	Cell A	6.3	77
			Cell B	3.2	69
			Cell C	4.3	70
			Cell D	5.2	77
	880-960	8	Cell A	5.6	83
			Cell B	4.4	70
			Cell C	3.9	64
			Cell D	4.7	79
	1427-1518	11, 21, 74,75,76	Cell A	4.0	69
			Cell B	5.3	66
			Cell C	5.1	64
			Cell D	5.0	70
1710-1920	2,3,4,9,25,35, 39,66	Cell A	4.5	75	
		Cell B	4.2	74	
		Cell C	4.2	75	
		Cell D	4.3	74	
1920-2170	1,23	Cell A	5.2	77	
		Cell B	4.4	78	
		Cell C	3.9	74	
		Cell D	5.0	79	
2300-2400	30,40	Cell A	4.7	73	
		Cell B	4.5	72	
		Cell C	3.7	68	
		Cell D	4.1	73	
2496-2690	7,38,41	Cell A	5.2	79	
		Cell B	5.2	75	
		Cell C	6.2	75	
		Cell D	4.9	76	
3300-4200	22,42,43,48,77, 78,79	Cell A	5.6	66	
		Cell B	5.5	70	
		Cell C	5.9	70	
		Cell D	5.9	66	
4400-5000	79	Cell A	7.0	60	
		Cell B	4.7	57	
		Cell C	6.0	60	
		Cell D	7.4	60	

Typical VSWR*

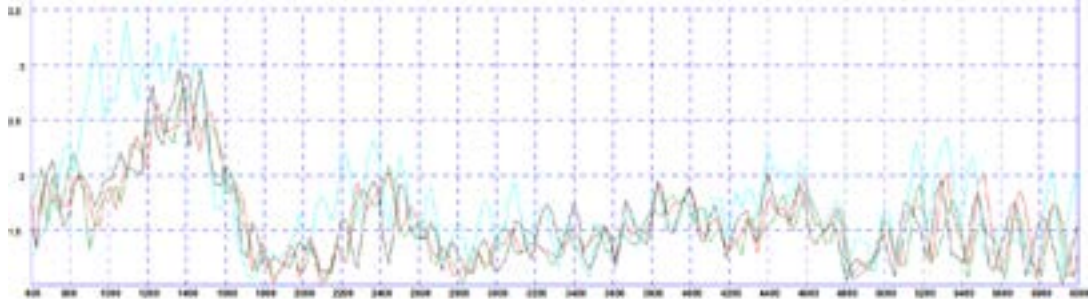

*Typical VSWR for elements 1-4 measured in free space with 0.5m (1.5') of CS32 cable.

Typical Isolation*

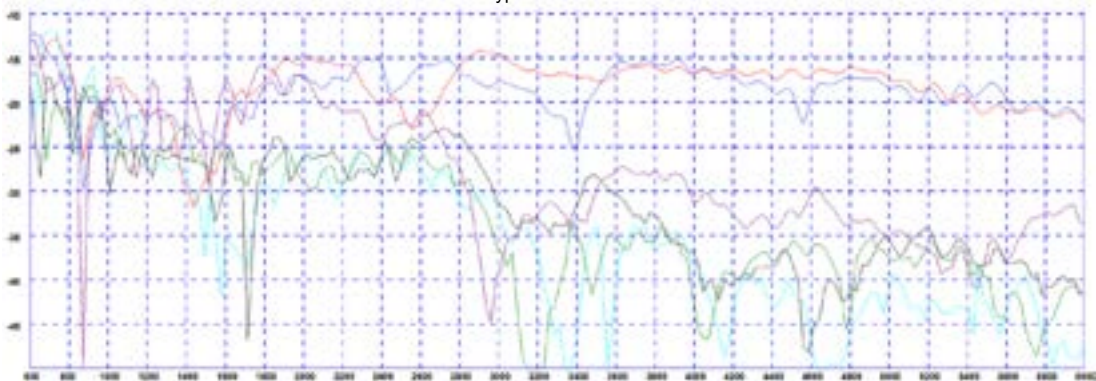

*Typical isolation measured for elements 1-4 in free space with 0.5(1.5') of CS32 cable.

Typical Efficiency*

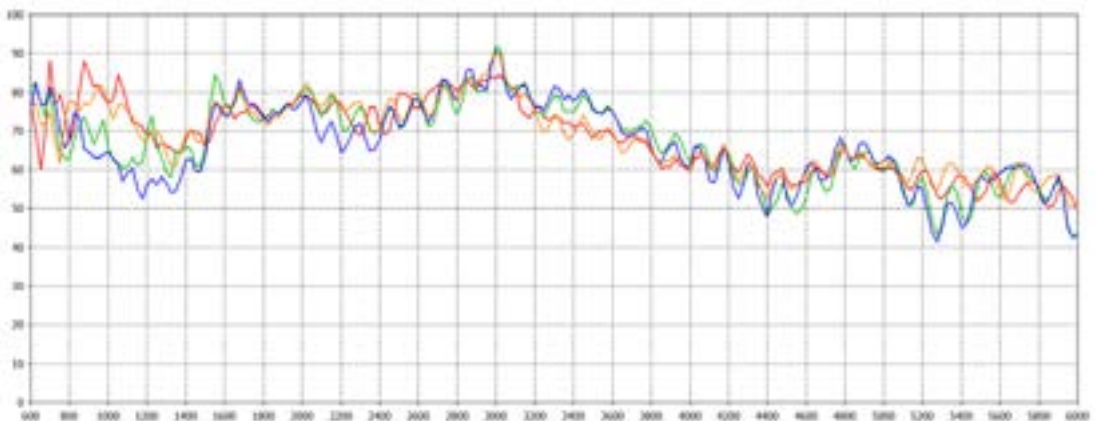

*Typical efficiency measured for elements 1-4 in free space with 0.5(1.5') of CS32 cable.

Typical Swept Peak Gain*



* Peak gain measured for elements 1-4 in free space with 0.5(1.5') of CS32 cable.

3D Patterns Cell A

Typical 3D Pattern- Cell A - 650 MHz

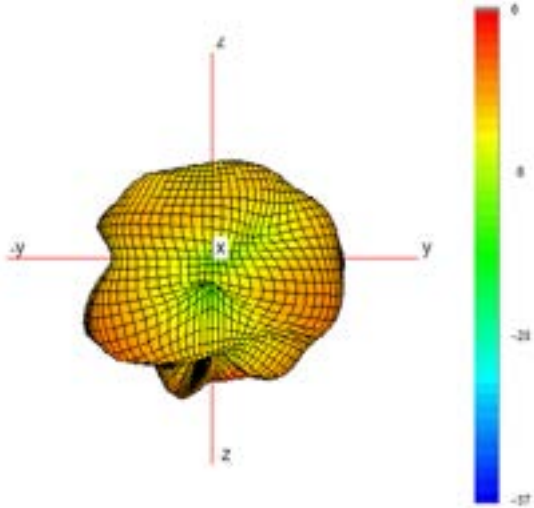

Typical H Plane- Cell A - Patterns- 600-700MHz

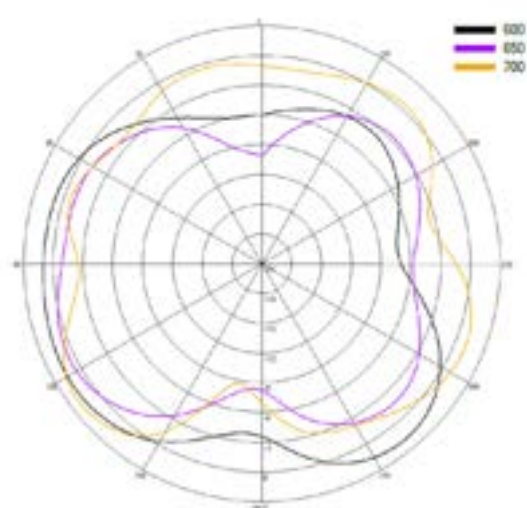

Typical 3D Pattern- Cell A - 750 MHz

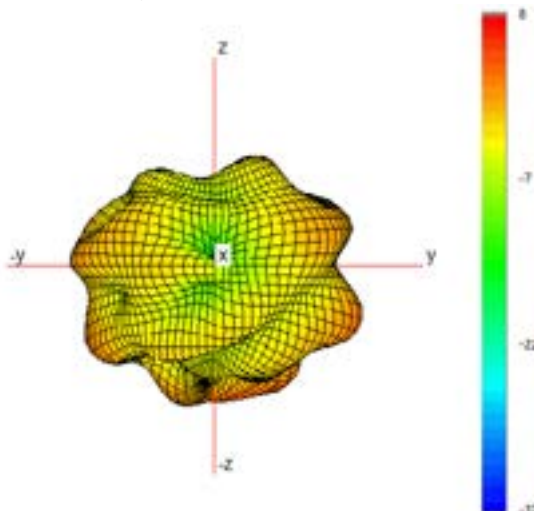

Typical H Plane- Cell A - Patterns- 700-800MHz

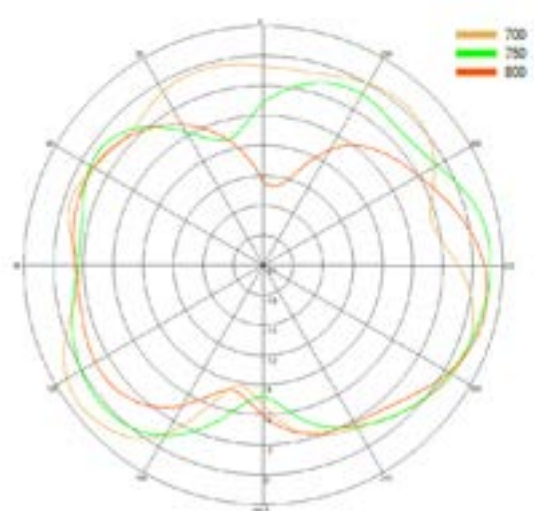

Typical 3D Pattern- Cell A - 850 MHz

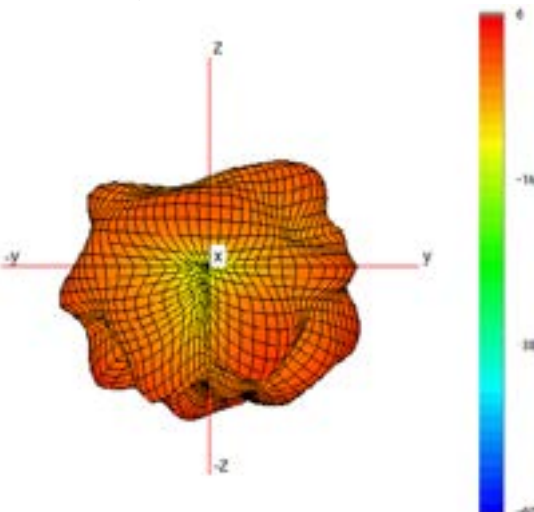

Typical H Plane- Cell A - Patterns- 800-900MHz

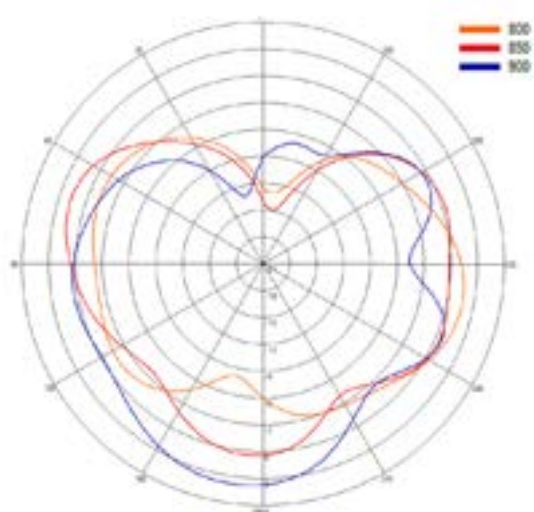

Typical 3D Pattern- Cell A - 1475 MHz

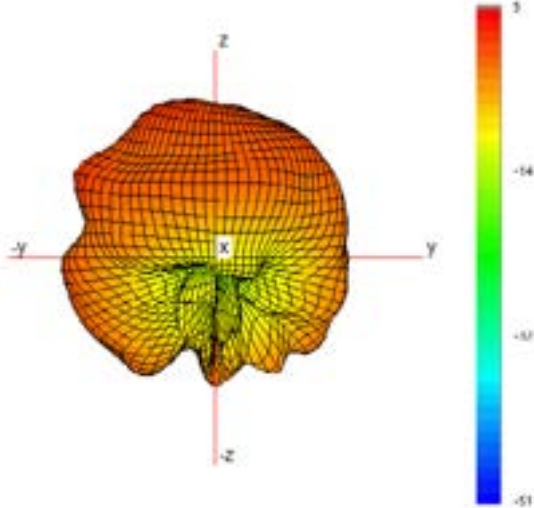

Typical H Plane- Cell A- Patterns- 1450-1500 MHz

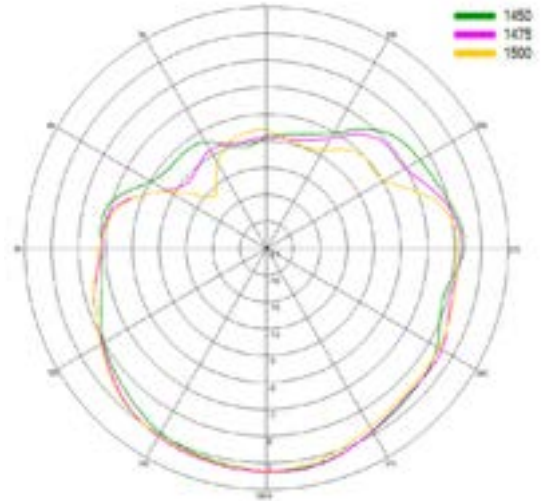

Typical 3D Pattern- Cell A - 1800 MHz

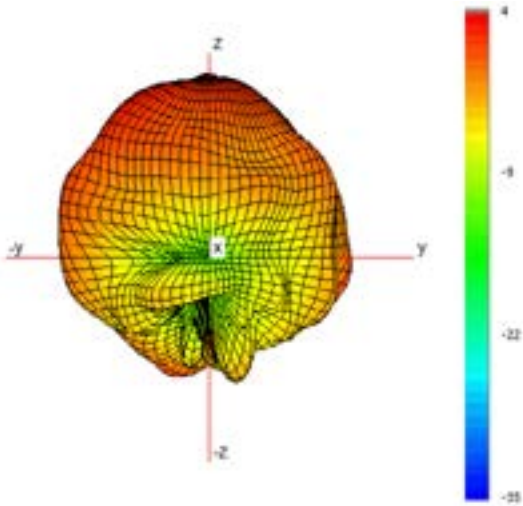

Typical H Plane- Cell A- Patterns- 1750-1850 MHz

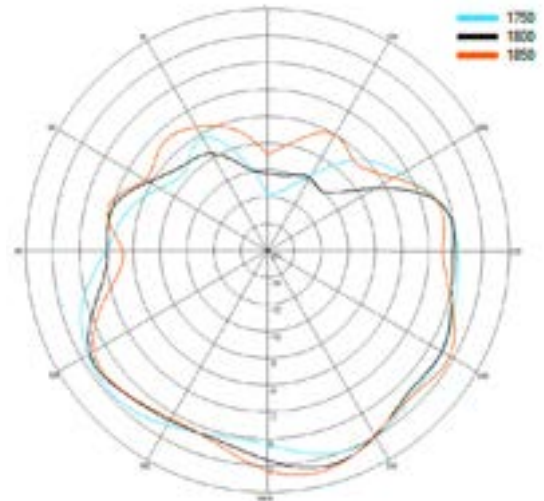

Typical 3D Pattern- Cell A - 2150 MHz

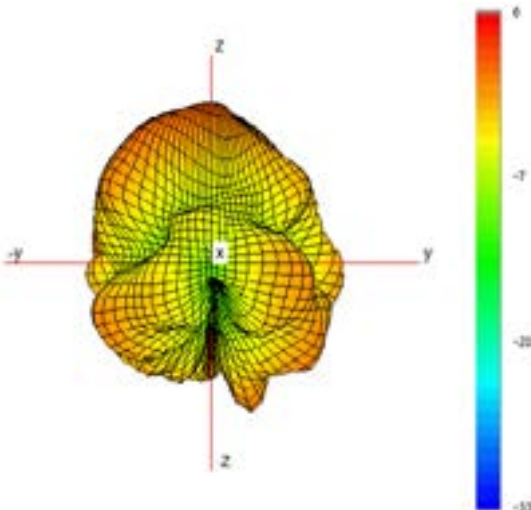

Typical H Plane- Cell A- Patterns- 2100-2200 MHz

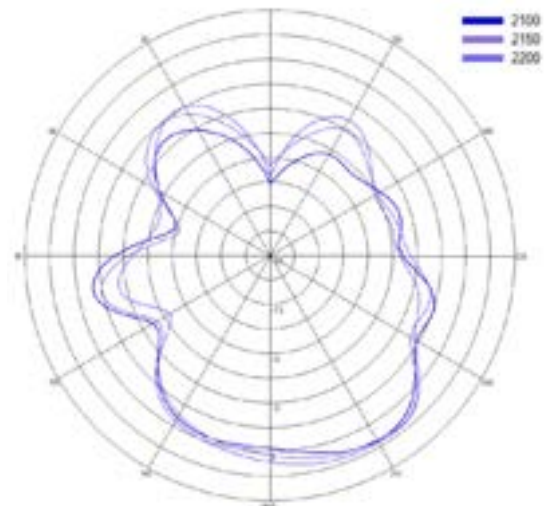

3D Patterns Cell A

Typical 3D Pattern- Cell A - 2350 MHz

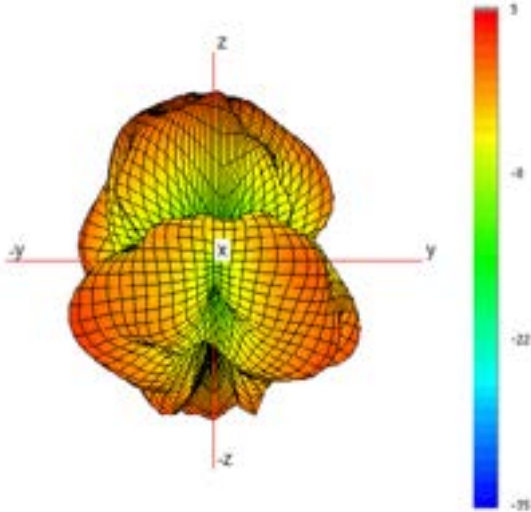

Typical H Plane- Cell A - Patterns- 2300-2400 MHz

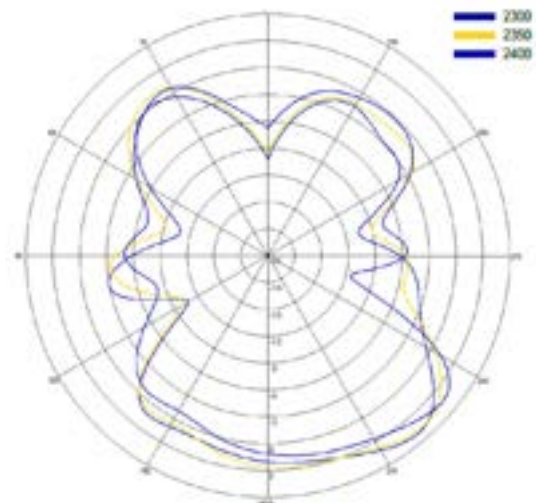

Typical 3D Pattern- Cell A - 2650 MHz

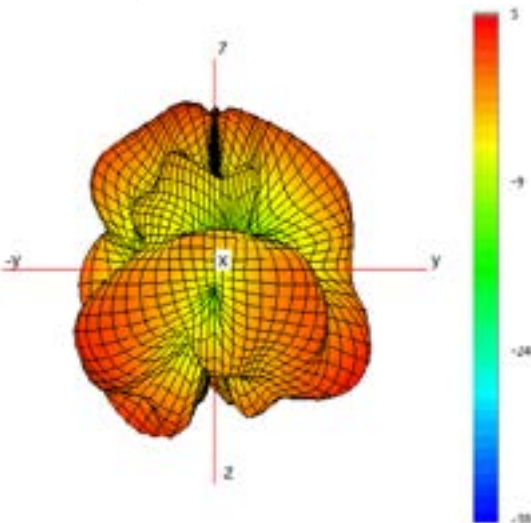

Typical H Plane- Cell A - Patterns- 2600-2700 MHz

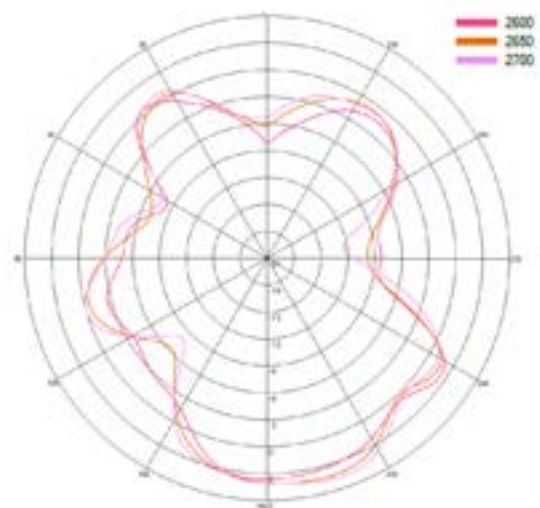

Typical 3D Pattern- Cell A - 3600 MHz

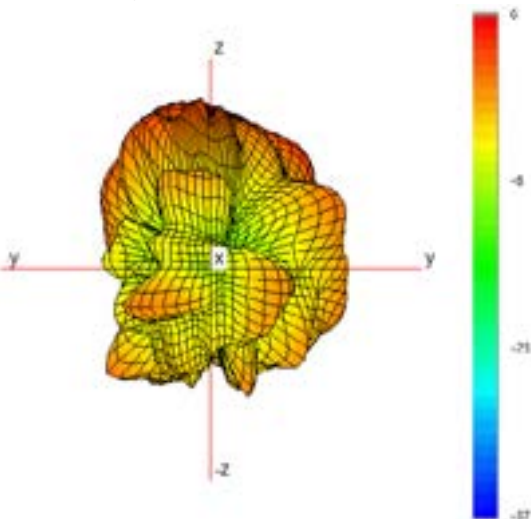

Typical H Plane- Cell A - Patterns- 3400-4000 MHz

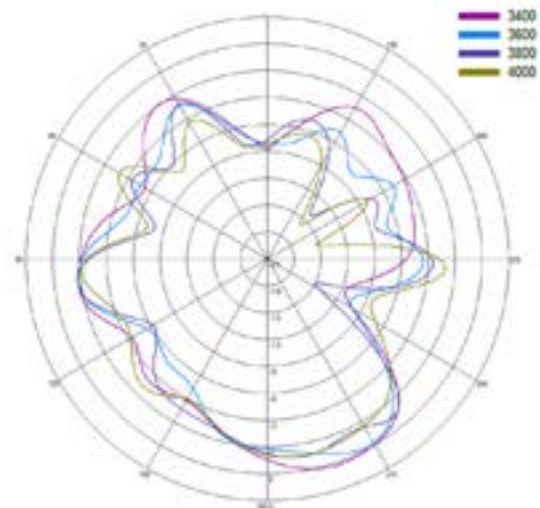

Typical 3D Pattern- Cell A - 4700 MHz

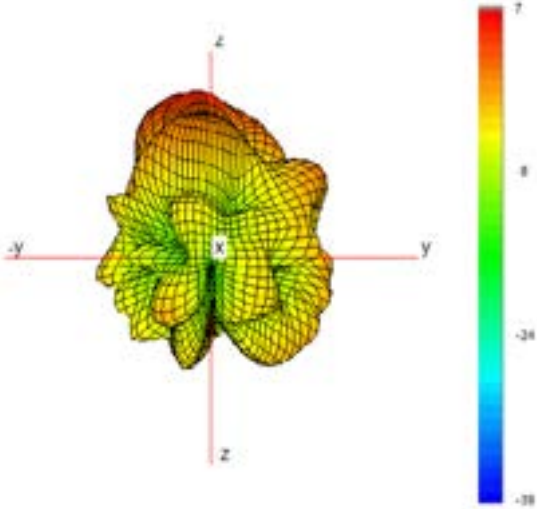

Typical H Plane- Cell A - Patterns- 4400-4800 MHz

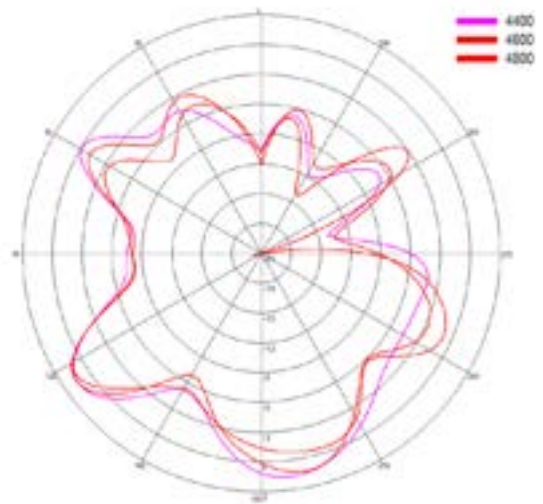

3D Patterns Cell B

Typical 3D Pattern- Cell B - 650 MHz

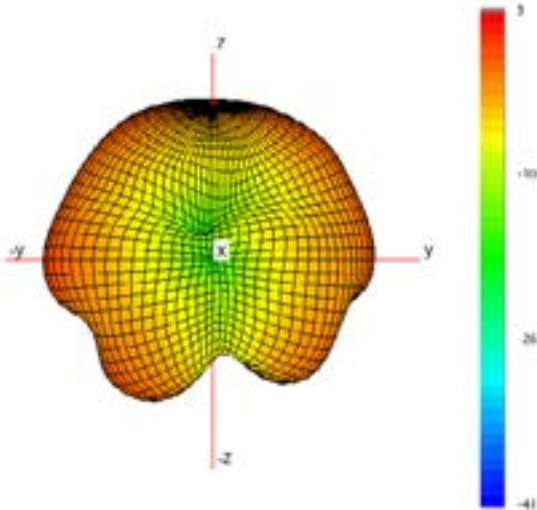

Typical H Plane- Cell B - Patterns- 600-700MHz

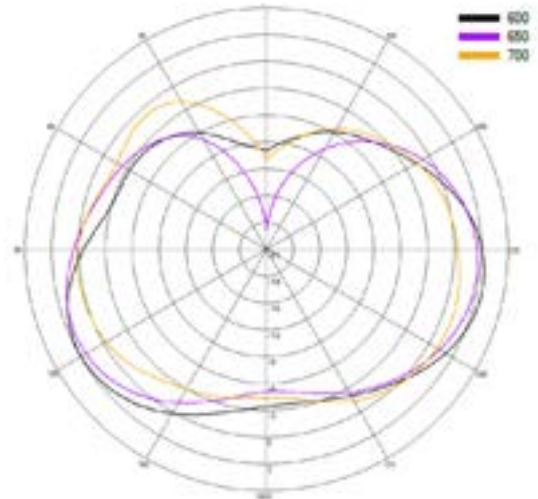

Typical 3D Pattern- Cell B - 750 MHz

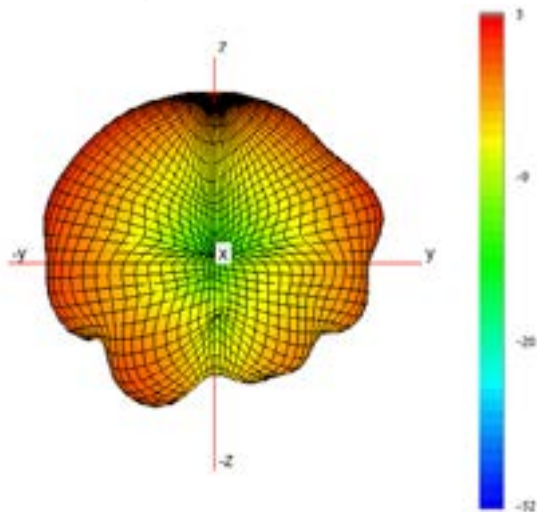

Typical H Plane- Cell B - Patterns- 700-800MHz

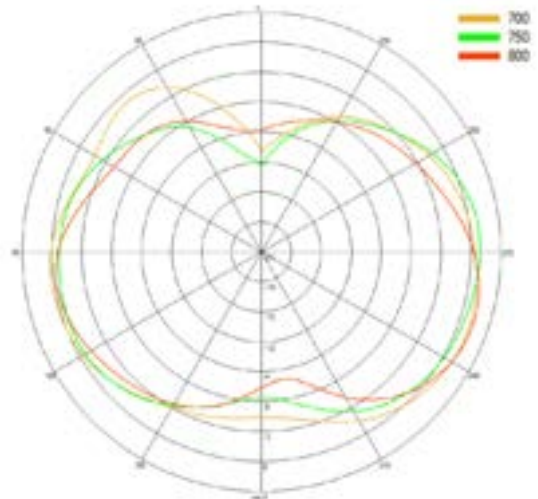

Typical 3D Pattern- Cell B - 850 MHz

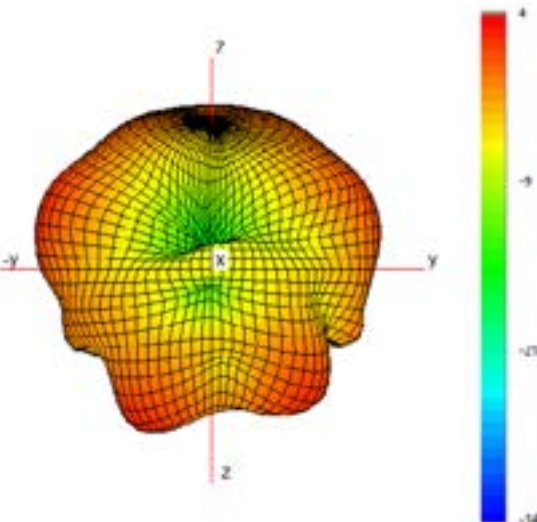

Typical H Plane- Cell B - Patterns- 800-900MHz

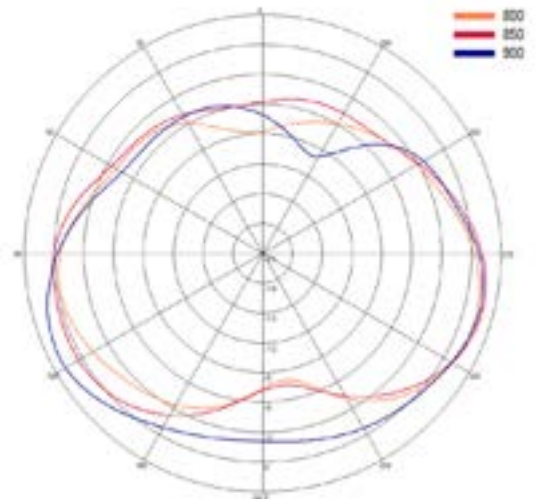

Typical 3D Pattern- Cell B - 1475 MHz

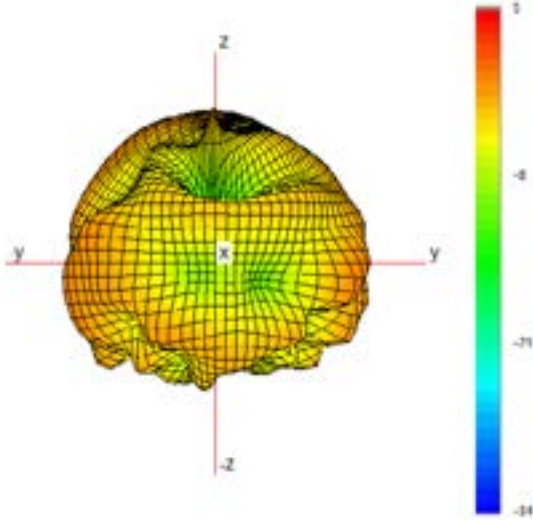

Typical H Plane- Cell B- Patterns- 1450-1500 MHz

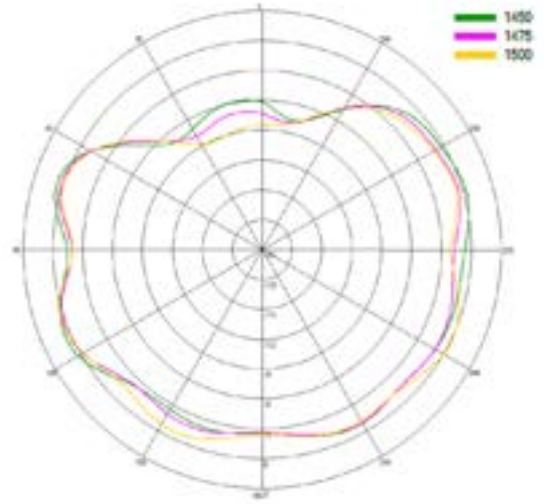

Typical 3D Pattern- Cell B - 1800 MHz

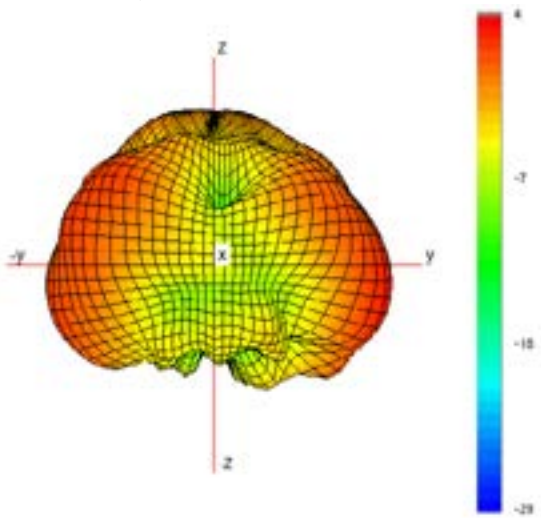

Typical H Plane- Cell B- Patterns- 1750-1850 MHz

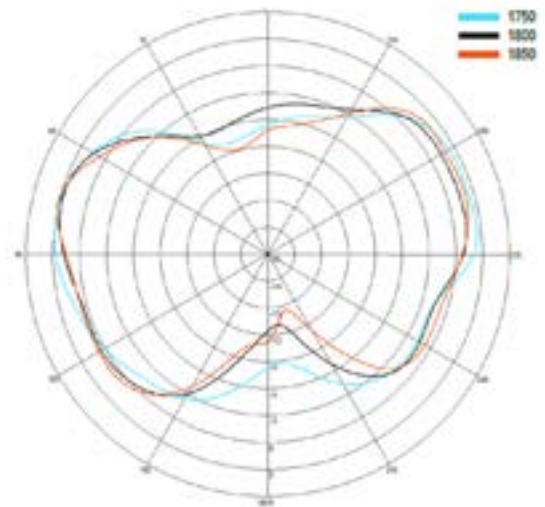

Typical 3D Pattern- Cell B - 2150 MHz

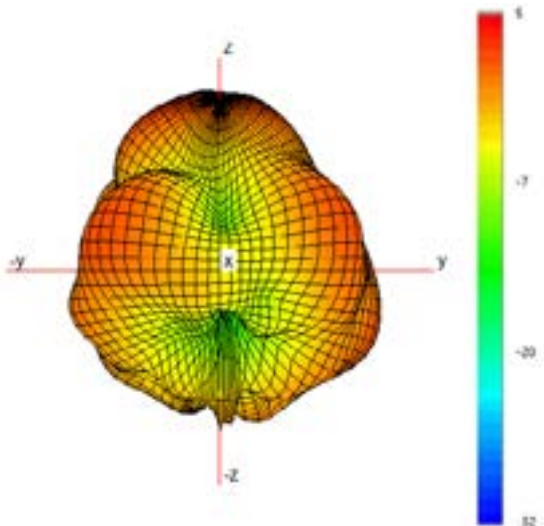

Typical H Plane- Cell B- Patterns- 2100-2200 MHz

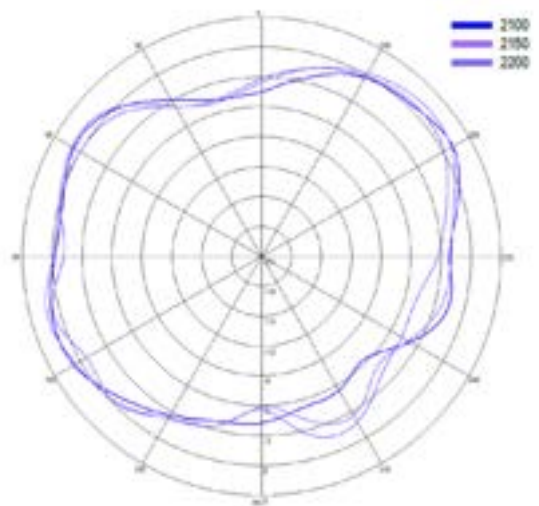

3D Patterns Cell B

Typical 3D Pattern- Cell B - 2350 MHz

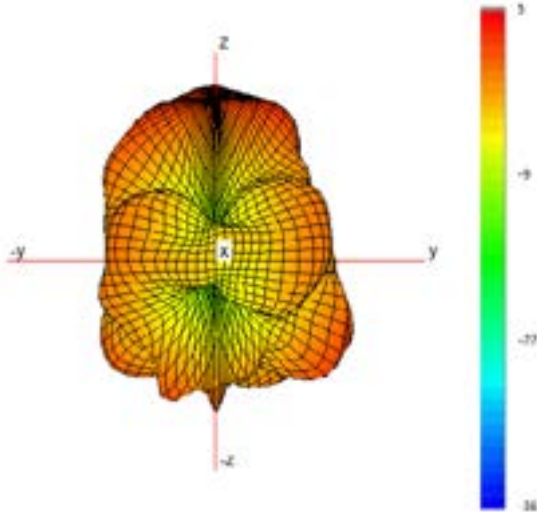

Typical H Plane- Cell B - Patterns- 2300-2400 MHz

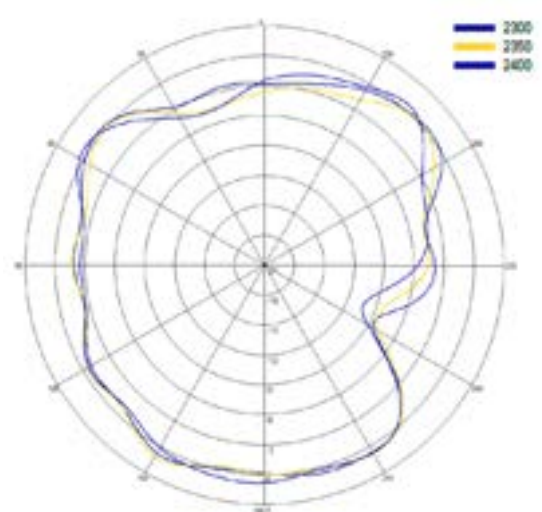

Typical 3D Pattern- Cell B - 2650 MHz

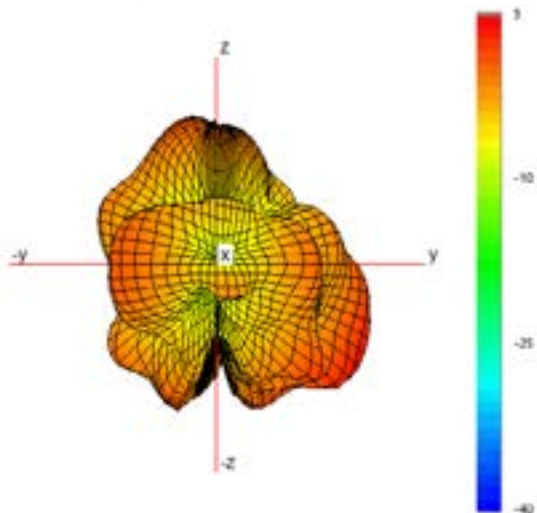

Typical H Plane- Cell B - Patterns- 2600-2700 MHz

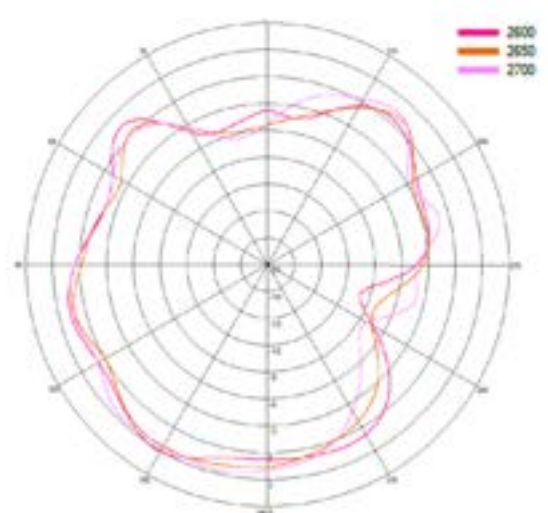

Typical 3D Pattern- Cell B - 3600 MHz

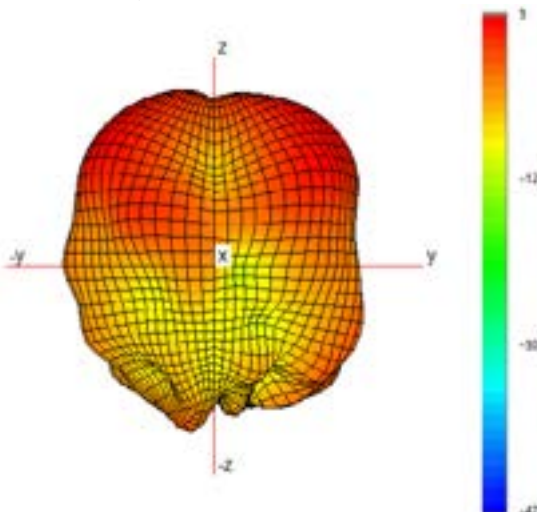

Typical H Plane- Cell B - Patterns- 3400-4000 MHz

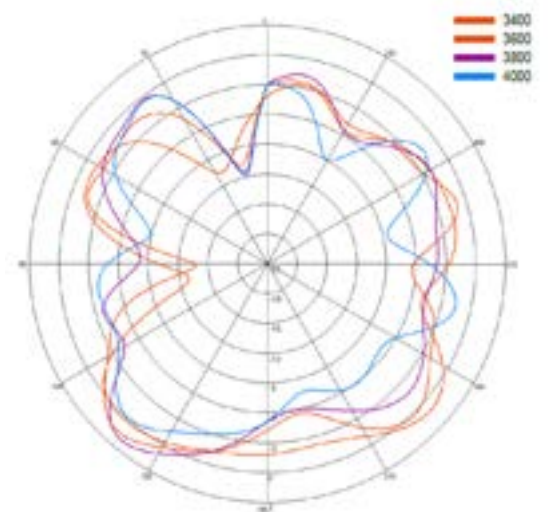

Typical 3D Pattern- Cell B - 4700 MHz

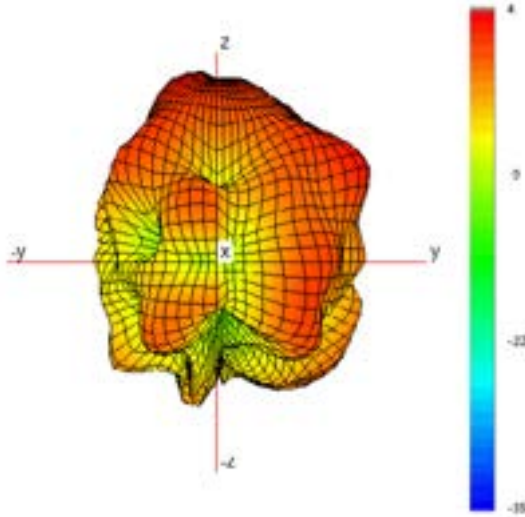

Typical H Plane- Cell B - Patterns- 4400-4800 MHz

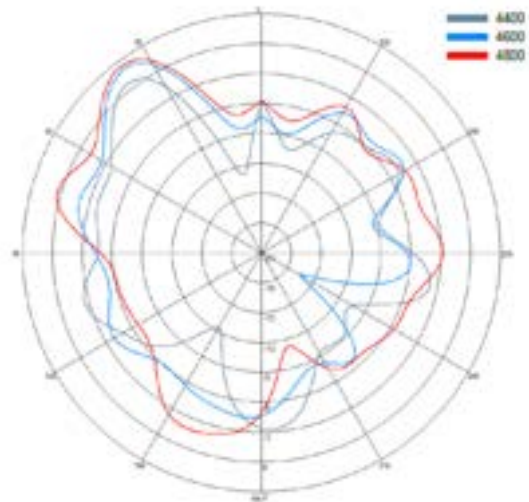

3D Patterns Cell C

Typical 3D Pattern- Cell C - 650 MHz

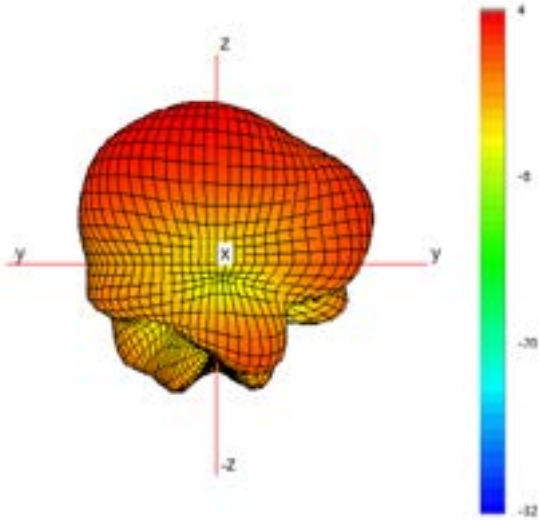

Typical H Plane- Cell C - Patterns- 600-700MHz

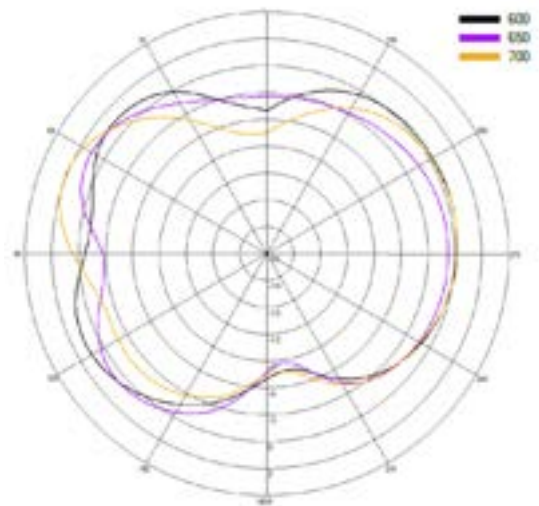

Typical 3D Pattern- Cell C - 750 MHz

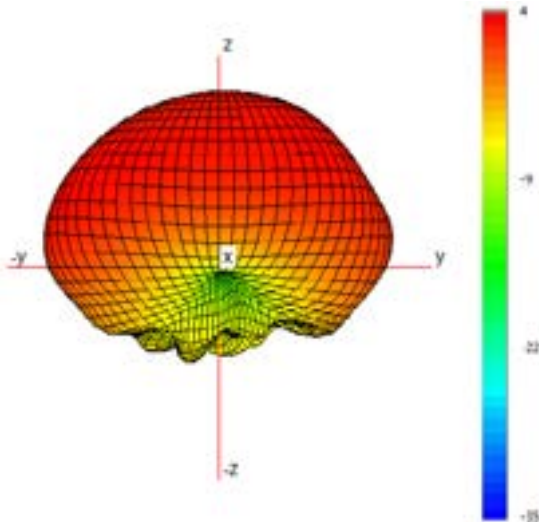

Typical H Plane- Cell C - Patterns- 700-800MHz

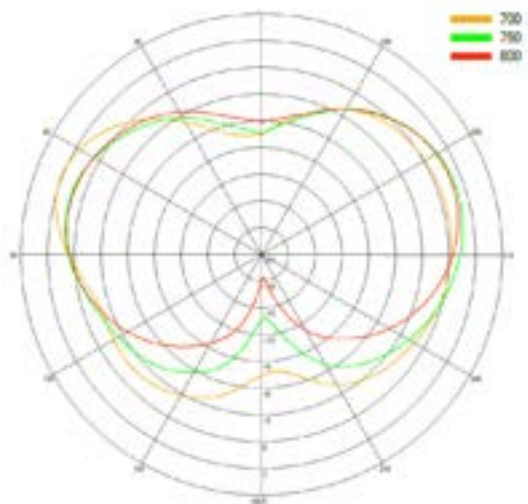

Typical 3D Pattern- Cell C - 850 MHz

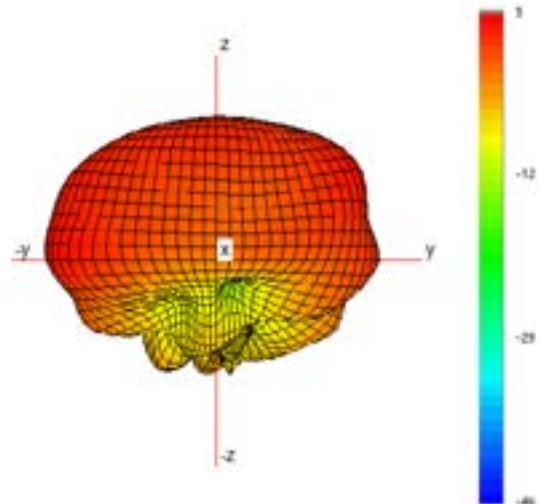

Typical H Plane- Cell C - Patterns- 800-900MHz

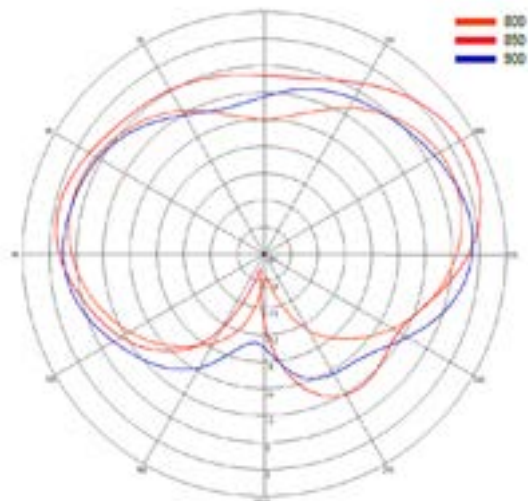

Typical 3D Pattern- Cell C - 1475 MHz

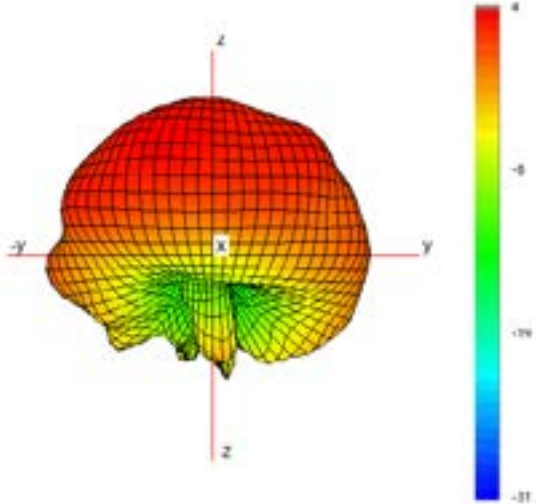

Typical H Plane- Cell C- Patterns- 1450-1500 MHz

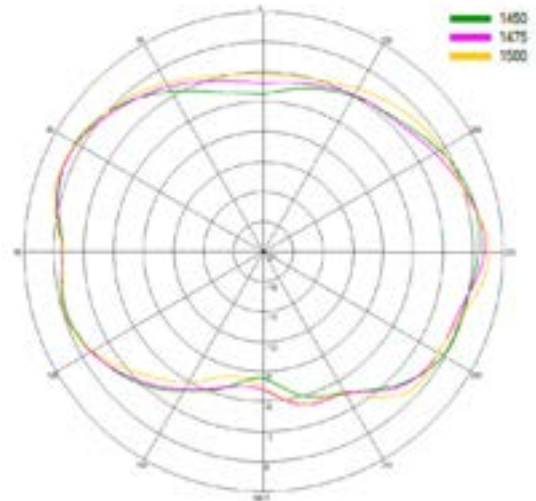

Typical 3D Pattern- Cell C - 1800 MHz

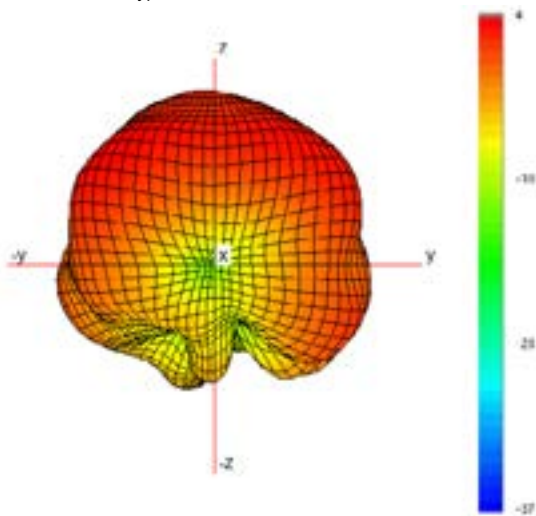

Typical H Plane- Cell C- Patterns- 1750-1850 MHz

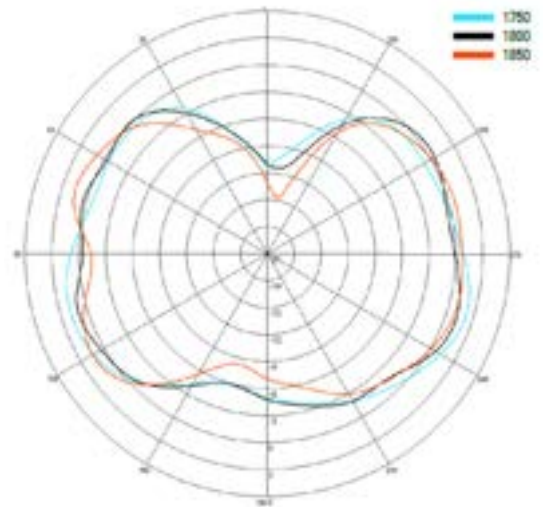

Typical 3D Pattern- Cell C - 2150 MHz

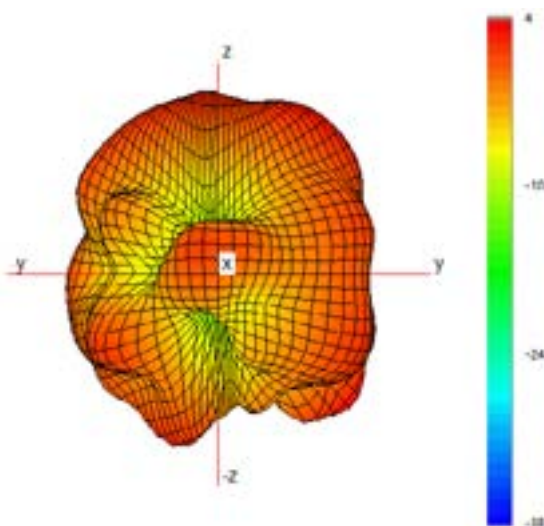

Typical H Plane- Cell C- Patterns- 2100-2200 MHz

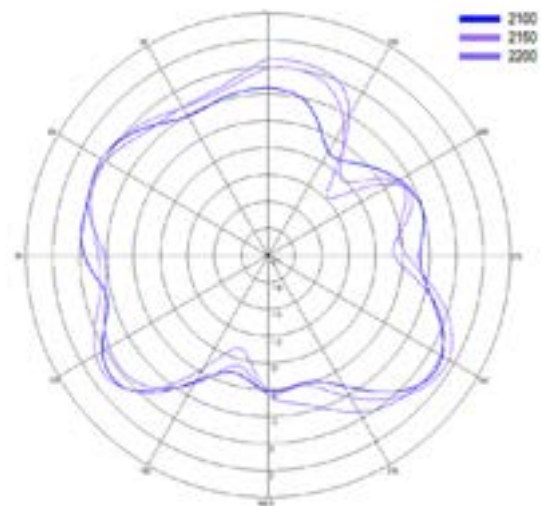

3D Patterns Cell C

Typical 3D Pattern- Cell C - 2350 MHz

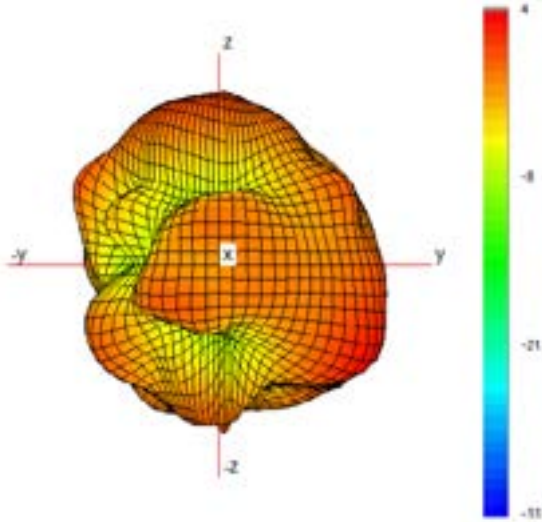

Typical H Plane- Cell C - Patterns- 2300-2400 MHz

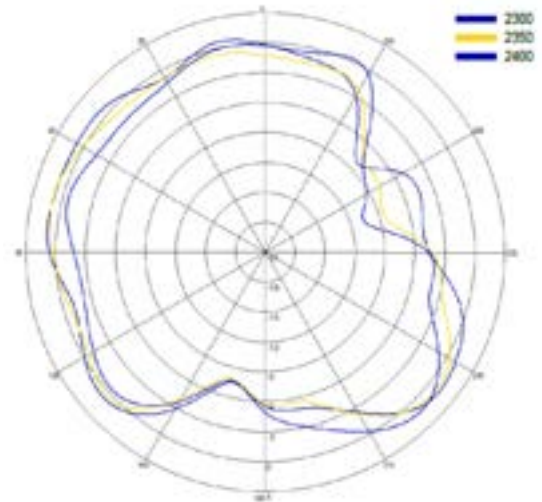

Typical 3D Pattern- Cell C - 2650 MHz

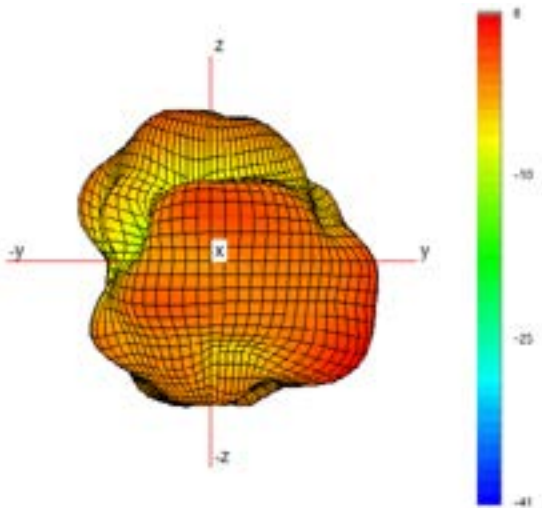

Typical H Plane- Cell C - Patterns- 2600-2700 MHz

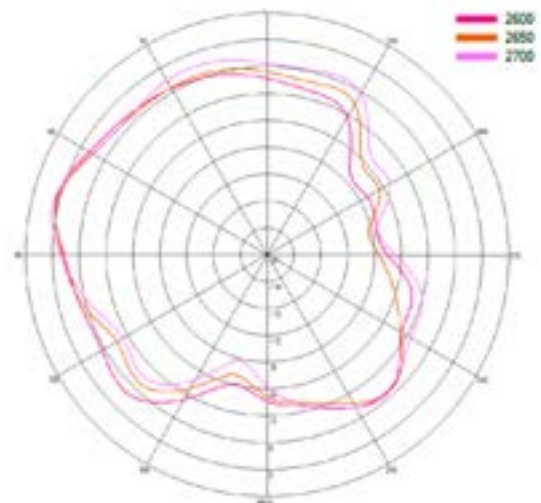

Typical 3D Pattern- Cell C - 3600 MHz

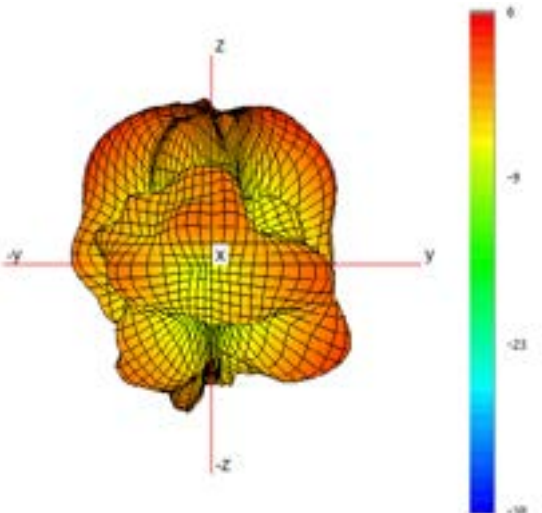

Typical H Plane- Cell C - Patterns- 3400-4000 MHz

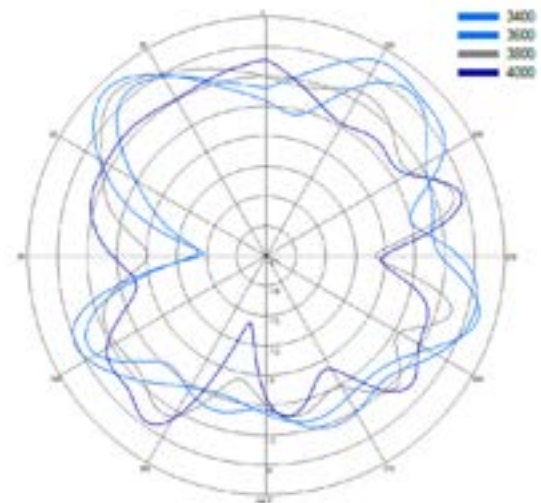

Typical 3D Pattern- Cell C - 4700 MHz

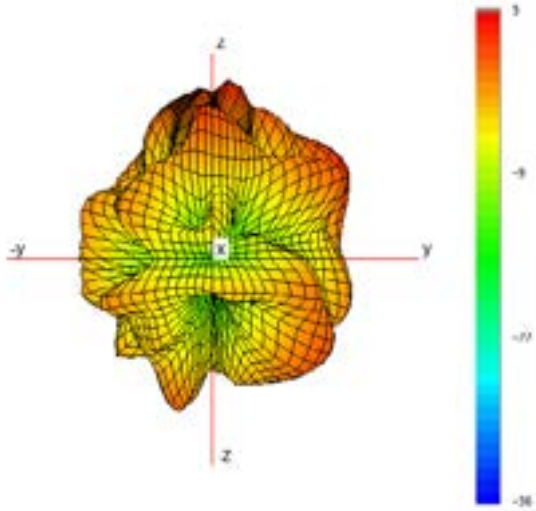

Typical H Plane- Cell C - Patterns- 4400-4800 MHz

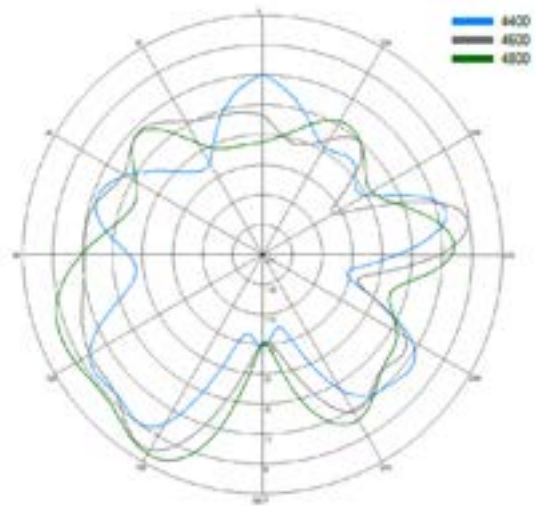

3D Patterns Cell D

Typical 3D Pattern- Cell D - 650 MHz

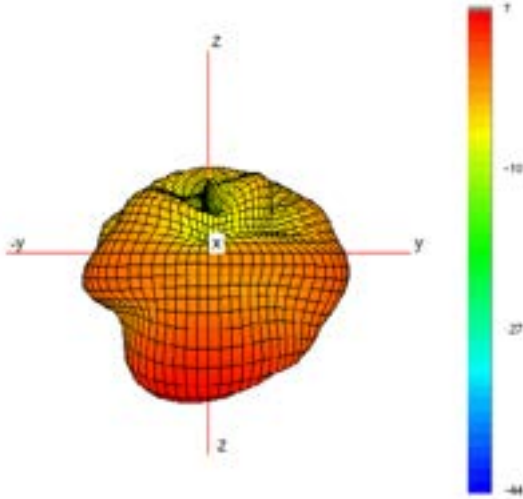

Typical H Plane- Cell D - Patterns- 600-700MHz

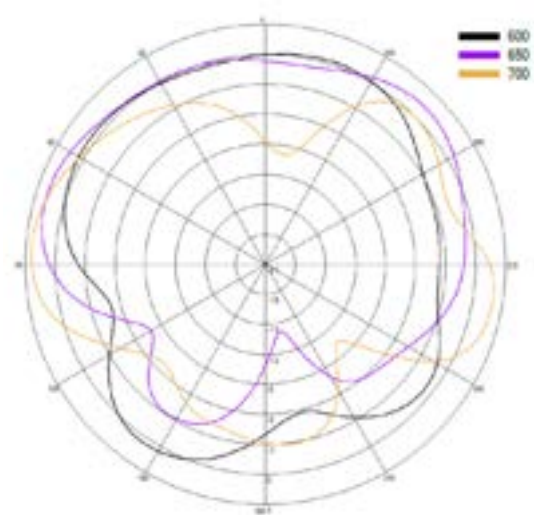

Typical 3D Pattern- Cell D - 750 MHz

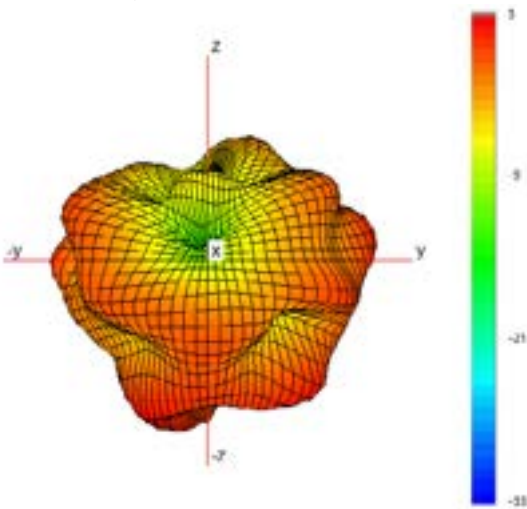

Typical H Plane- Cell D - Patterns- 700-800MHz

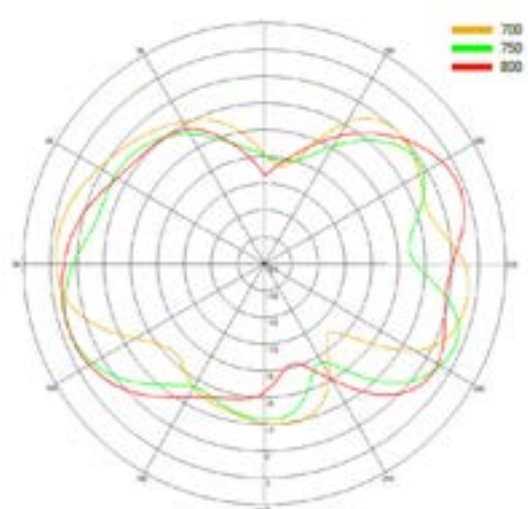

Typical 3D Pattern- Cell D - 850 MHz

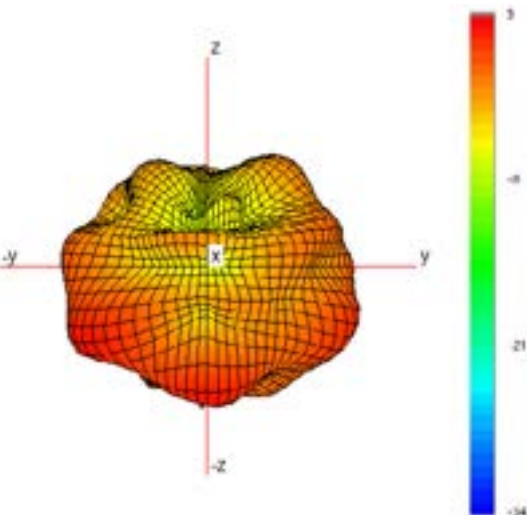

Typical H Plane- Cell D - Patterns- 800-900MHz

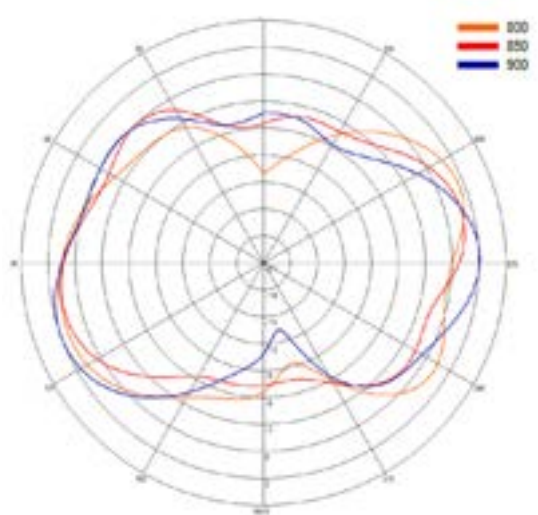

Typical 3D Pattern- Cell D - 1475 MHz

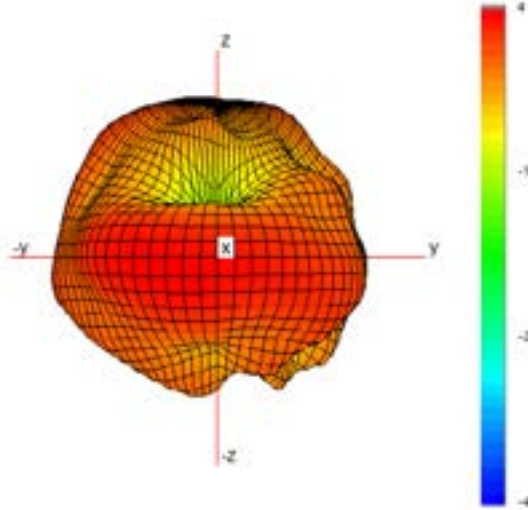

Typical H Plane- Cell D- Patterns- 1450-1500 MHz

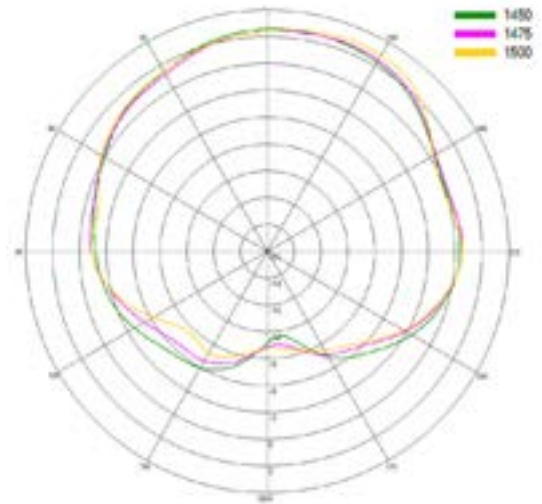

Typical 3D Pattern- Cell D - 1800 MHz

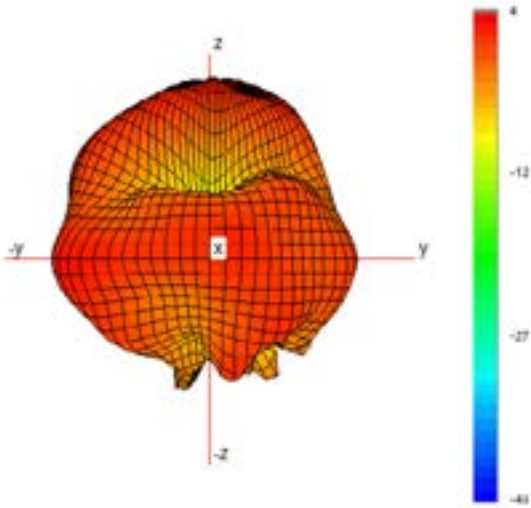

Typical H Plane- Cell D- Patterns- 1750-1850 MHz

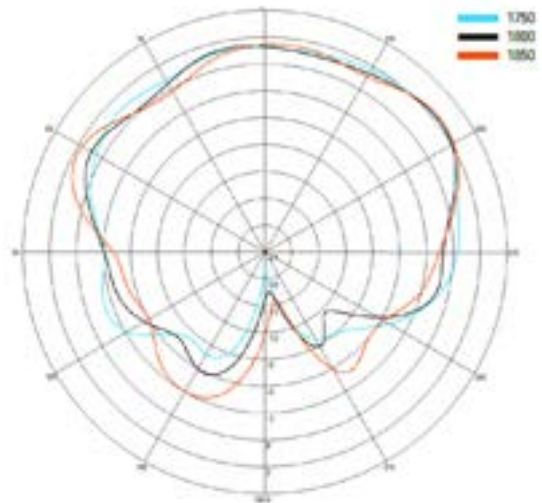

Typical 3D Pattern- Cell D - 2150 MHz

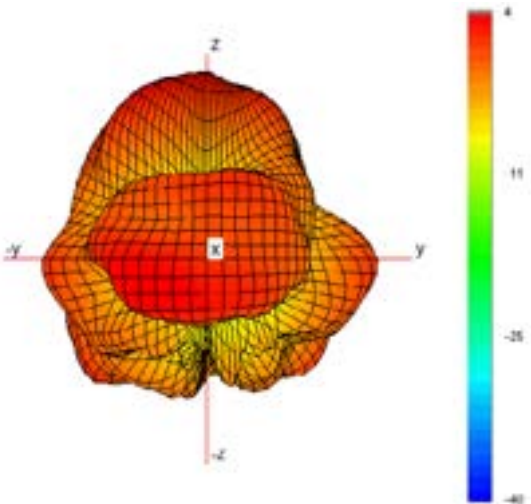

Typical H Plane- Cell D- Patterns- 2100-2200 MHz

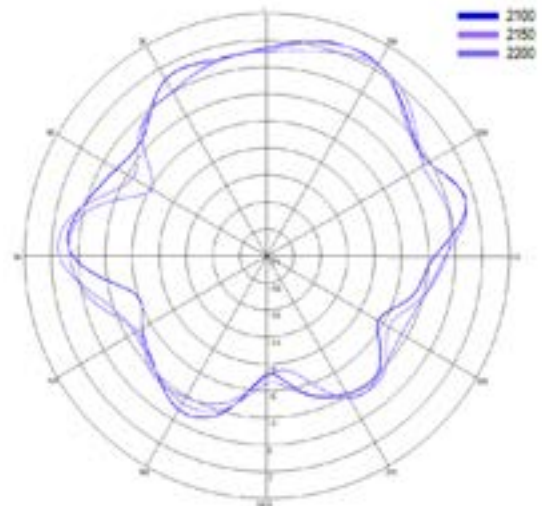

3D Patterns Cell D

Typical 3D Pattern- Cell D - 2350 MHz

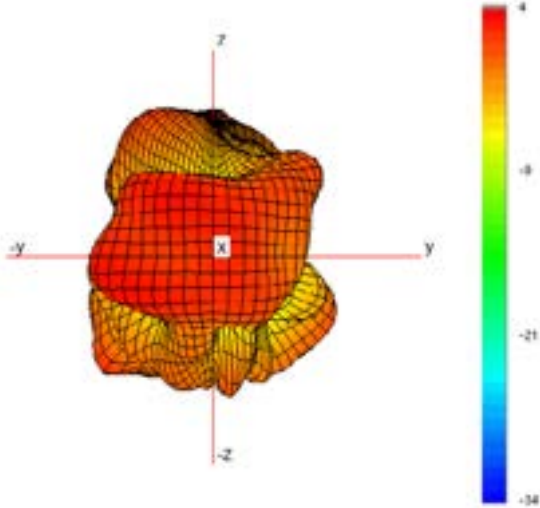

Typical H Plane- Cell D - Patterns- 2300-2400 MHz

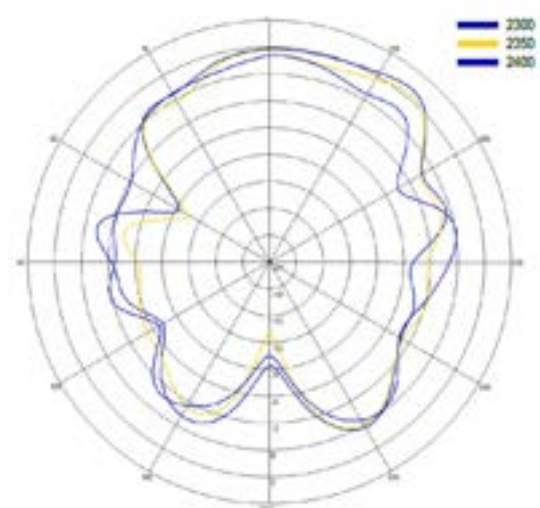

Typical 3D Pattern- Cell D - 2650 MHz

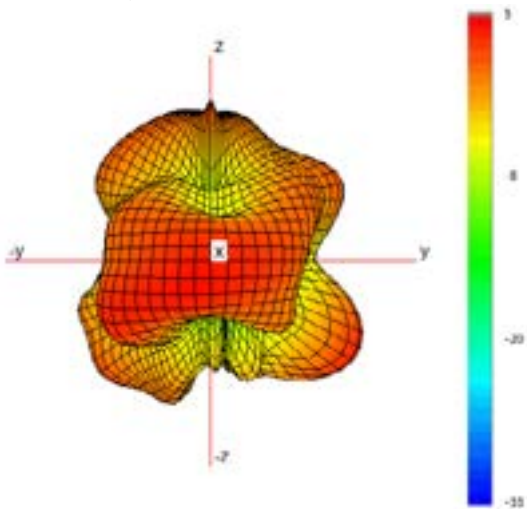

Typical H Plane- Cell D - Patterns- 2600-2700 MHz

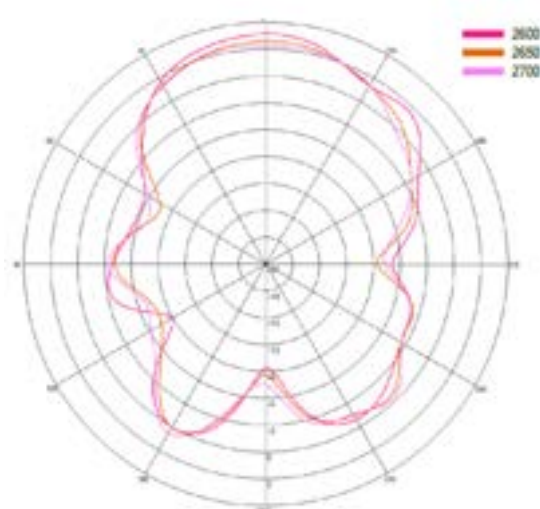

Typical 3D Pattern- Cell D - 3600 MHz

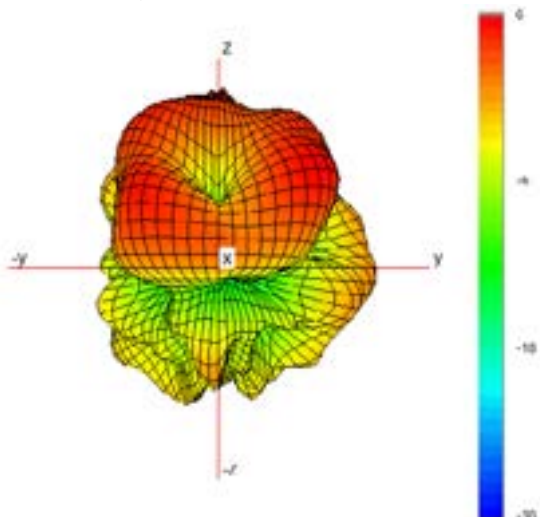

Typical H Plane- Cell D - Patterns- 3400-4000 MHz

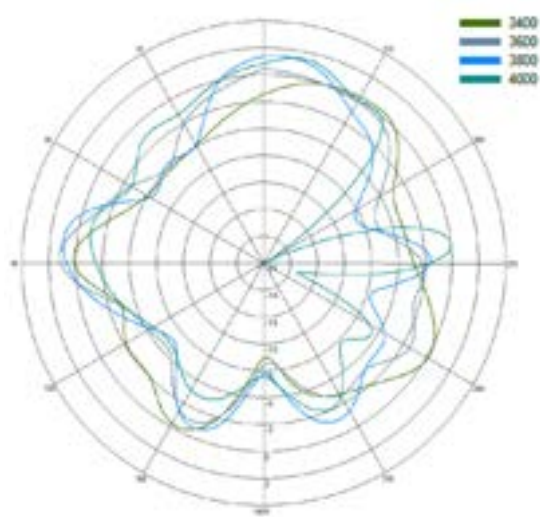

Typical 3D Pattern- Cell D - 4700 MHz

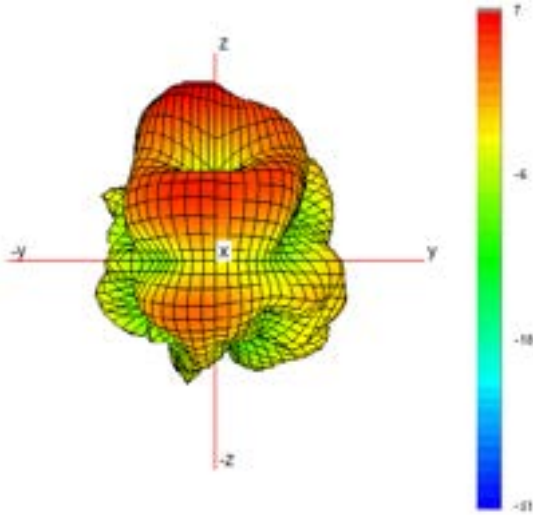

Typical H Plane- Cell D - Patterns- 4400-4800 MHz

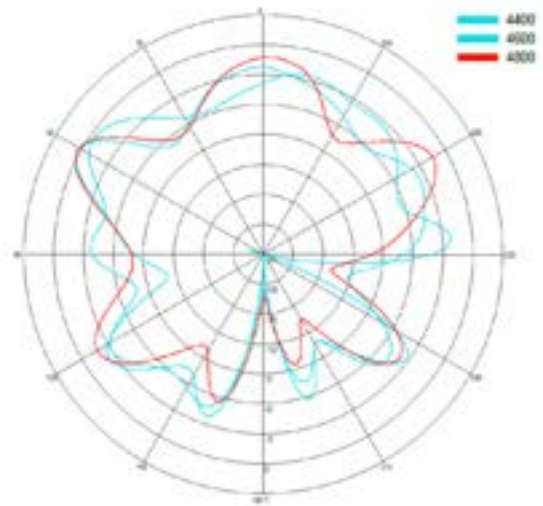

Electrical Data- L1
GPS/GNSS

Swept Peak Gain GPS/GNSS

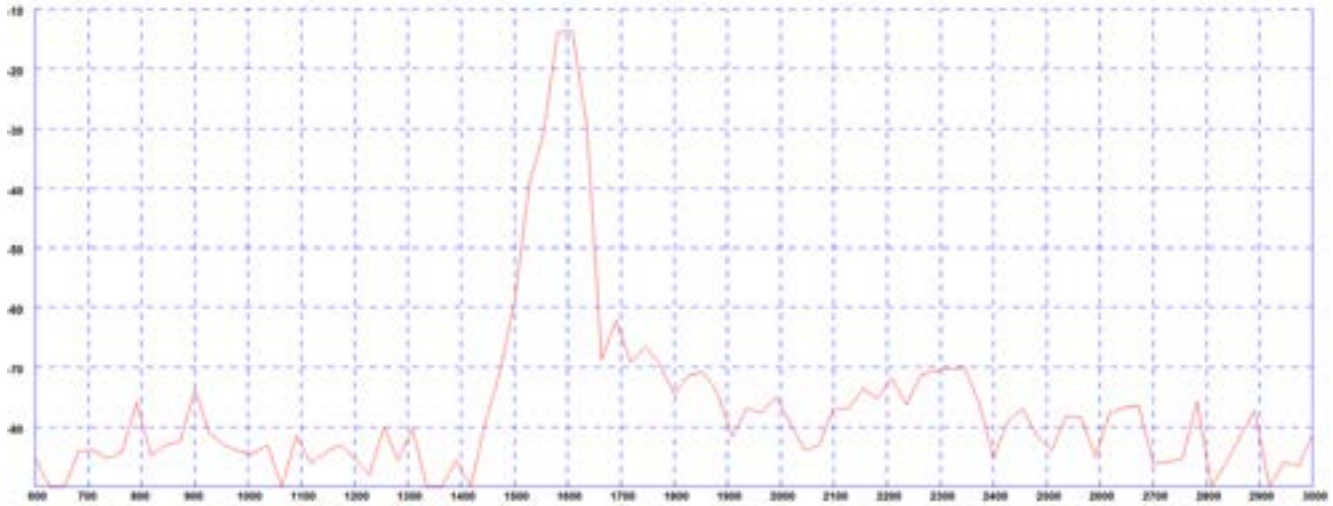

Typical E Plane Pattern - GPS/GNSS 1575 MHz

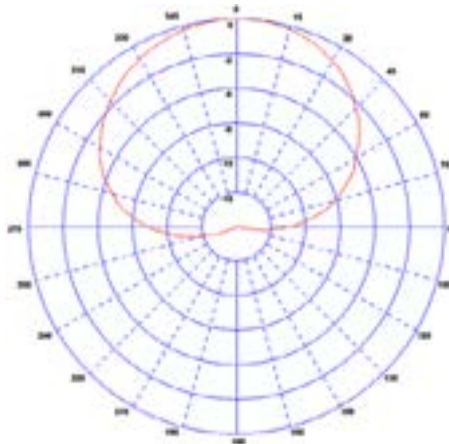

Typical E Plane Pattern - GPS/GNSS 1602 MHz

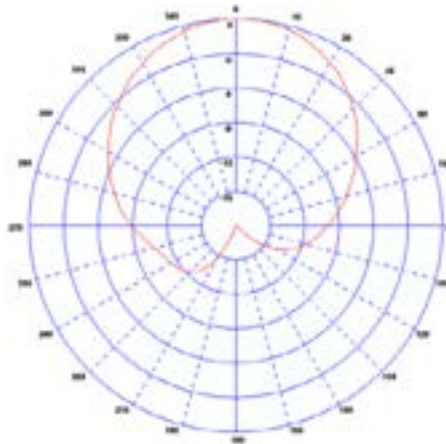

GPS/GNSS Measurements taken on 190x190mm (7.4" x 7.4") ground plane excluding cable loss

Swept Peak Gain GPS/GNSS

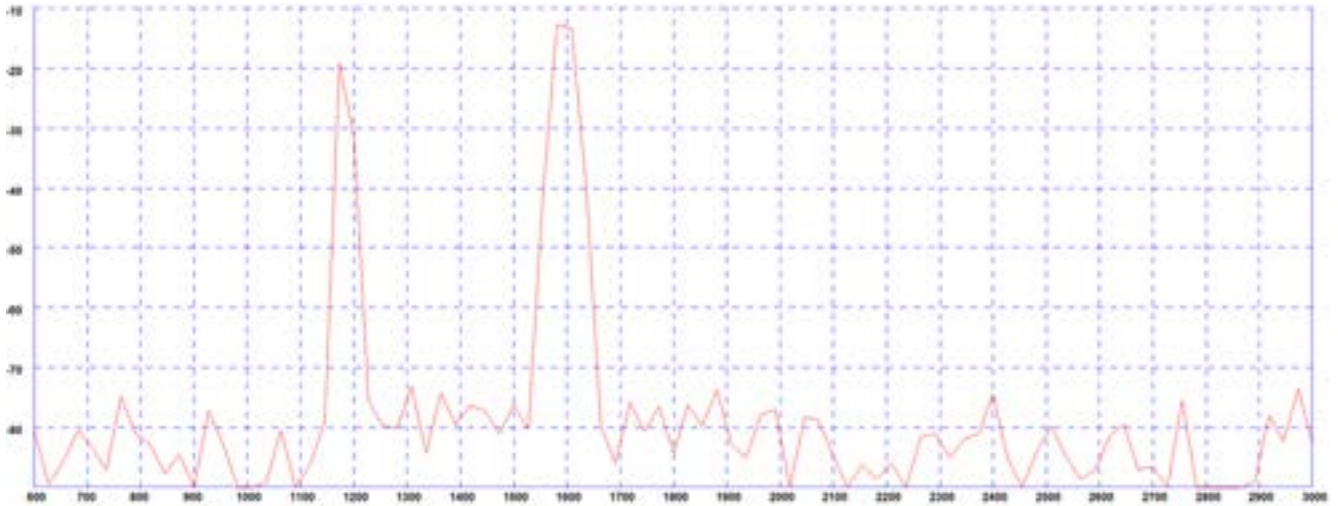

Typical E Plane Pattern - GPS/GNSS 1575 MHz

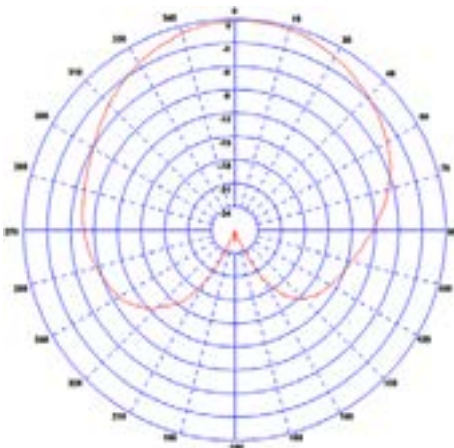

Typical E Plane Pattern - GPS/GNSS 1602 MHz

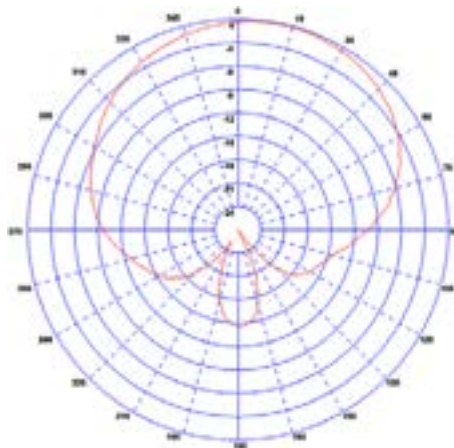

Typical E Plane Pattern - GPS/GNSS 1176 MHz

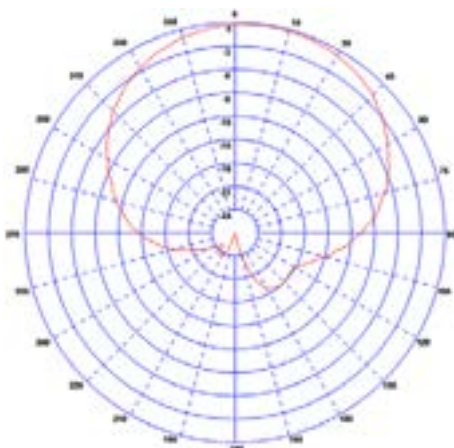

GPS/GNSS Measurements taken on 190x190mm (7.4" x 7.4") ground plane excluding cable loss